

# Memory Management Strategies

Chapter -8

# Chapter 8: Memory Management

- Background
- Swapping
- Contiguous Memory Allocation
- Segmentation
- Paging
- Structure of the Page Table

# Objectives

- To provide a detailed description of various ways of organizing memory hardware
- To discuss various memory-management techniques, including paging and segmentation
- To provide a detailed description of the Intel Pentium, which supports both pure segmentation and segmentation with paging

# Background

- Program must be brought (from disk) into memory and placed within a process for it to be run
- Main memory and registers are only storage CPU can access directly
- Memory unit only sees a stream of addresses + read requests, or address + data and write requests
- Register access in one CPU clock (or less)
- Main memory can take many cycles, causing a **stall**
- **Cache** sits between main memory and CPU registers
- Protection of memory required to ensure correct operation

# Base and Limit Registers

- A pair of **base** and **limit registers** define the logical address space
- CPU must check every memory access generated in user mode to be sure it is between base and limit for that user

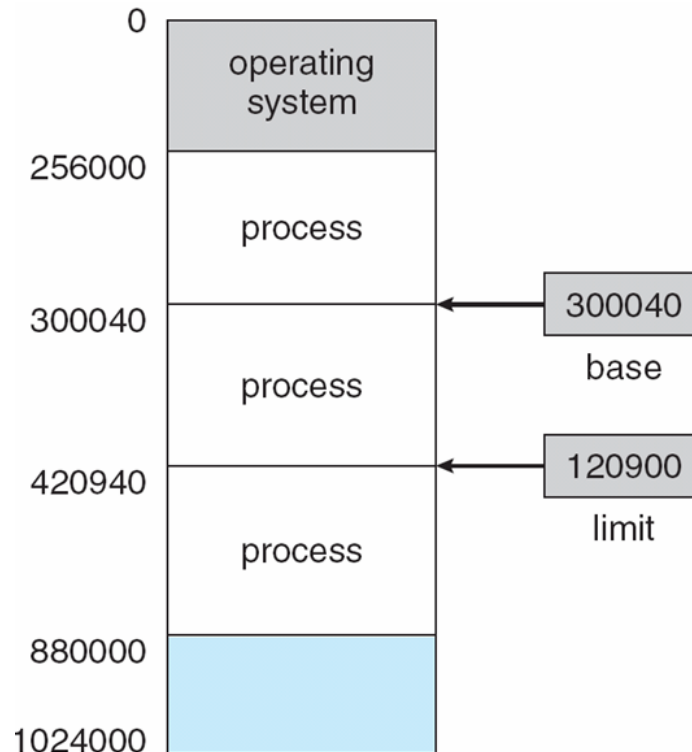

# Hardware Address Protection

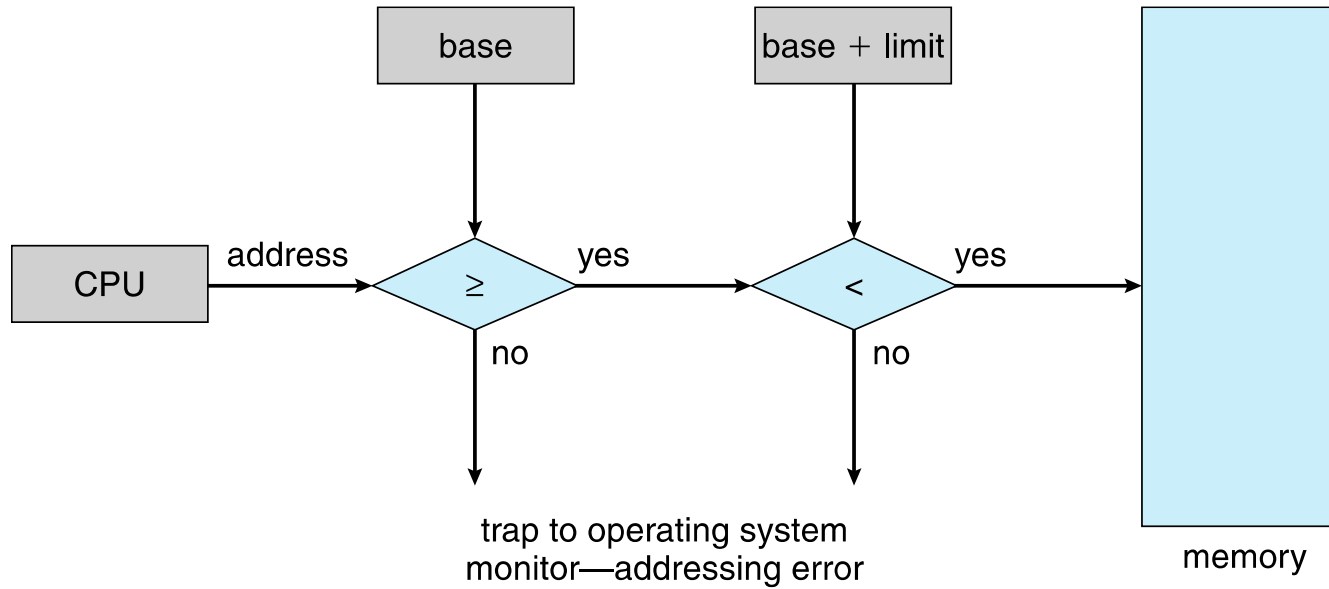

# Address Binding

- Programs on disk, ready to be brought into memory to execute form an **input queue**
  - Without support, must be loaded into address 0000
- Inconvenient to have first user process physical address always at 0000
  - How can it not be?
- Further, addresses represented in different ways at different stages of a program's life
  - Source code addresses usually symbolic
  - Compiled code addresses **bind** to relocatable addresses
    - i.e. “14 bytes from beginning of this module”
  - Linker or loader will bind relocatable addresses to absolute addresses
    - i.e. 74014
  - Each binding maps one address space to another

# Binding of Instructions and Data to Memory

- Address binding of instructions and data to memory addresses can happen at three different stages
  - **Compile time:** If memory location known a priori, **absolute code** can be generated; must recompile code if starting location changes
  - **Load time:** Must generate **relocatable code** if memory location is not known at compile time
  - **Execution time:** Binding delayed until run time if the process can be moved during its execution from one memory segment to another
    - Need hardware support for address maps (e.g., base and limit registers)



# Multistep Processing of a User Program

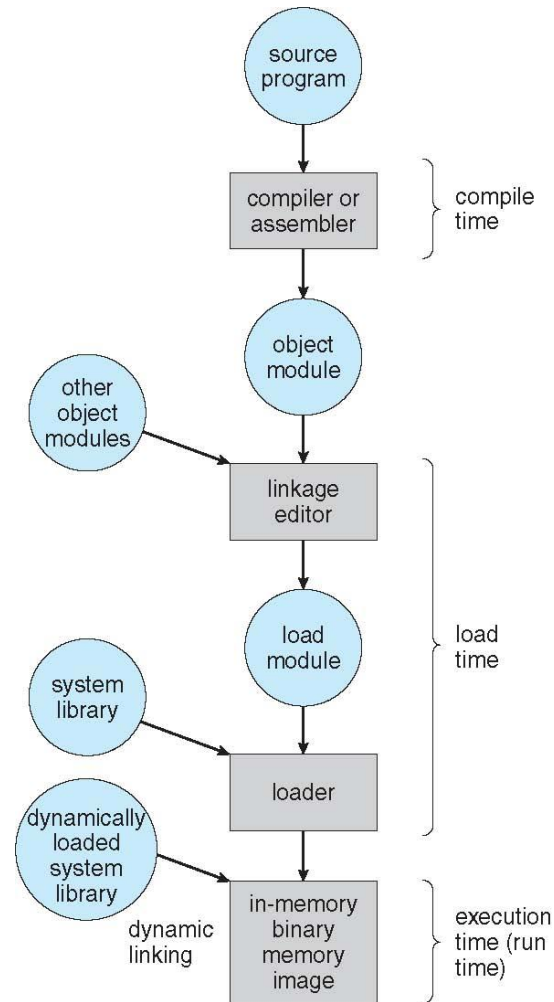

# Logical vs. Physical Address Space

- The concept of a logical address space that is bound to a separate **physical address space** is central to proper memory management
  - **Logical address** – generated by the CPU; also referred to as **virtual address**
  - **Physical address** – address seen by the memory unit
- Logical and physical addresses are the same in compile-time and load-time address-binding schemes; logical (virtual) and physical addresses differ in execution-time address-binding scheme
- **Logical address space** is the set of all logical addresses generated by a program
- **Physical address space** is the set of all physical addresses generated by a program.

# Memory-Management Unit

- Hardware device that at run time maps virtual to physical address
- Many methods possible, covered in the rest of this chapter
- To start, consider simple scheme where the value in the relocation register is added to every address generated by a user process at the time it is sent to memory
  - Base register now called **relocation register**
  - MS-DOS on Intel 80x86 used 4 relocation registers
- The user program deals with *logical* addresses; it never sees the *real* physical addresses
  - Execution-time binding occurs when reference is made to location in memory
  - Logical address bound to physical addresses

# Dynamic relocation using a relocation register

- Routine is not loaded until it is called
- Better memory-space utilization; unused routine is never loaded
- All routines kept on disk in relocatable load format
- Useful when large amounts of code are needed to handle infrequently occurring cases
- No special support from the operating system is required
  - Implemented through program design
  - OS can help by providing libraries to implement dynamic loading

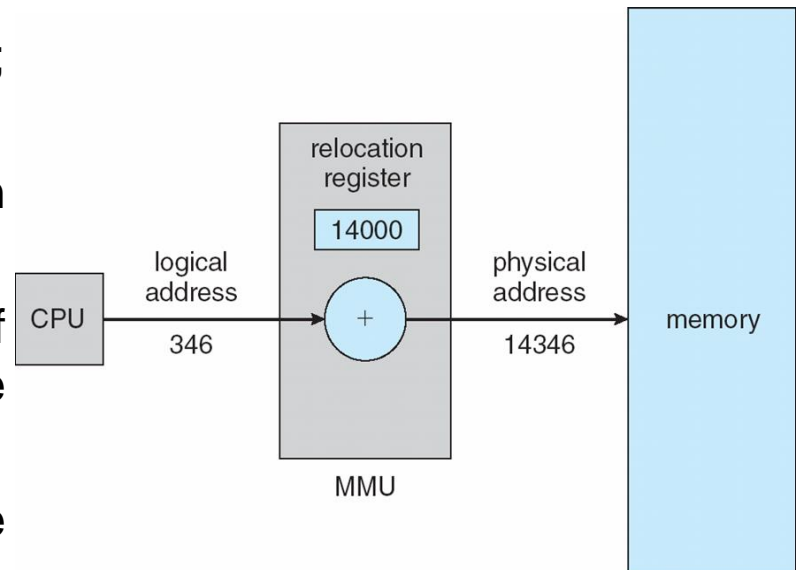

# Dynamic Linking

- **Static linking** – system libraries and program code combined by the loader into the binary program image
- Dynamic linking – linking postponed until execution time
- Small piece of code, **stub**, used to locate the appropriate memory-resident library routine
- Stub replaces itself with the address of the routine, and executes the routine
- Operating system checks if routine is in processes' memory address
  - If not in address space, add to address space
- Dynamic linking is particularly useful for libraries
- System also known as **shared libraries**
- Consider applicability to patching system libraries
  - Versioning may be needed

# Swapping

- A process can be **swapped** temporarily out of memory to a backing store, and then brought back into memory for continued execution
  - Total physical memory space of processes can exceed physical memory
- **Backing store** – fast disk large enough to accommodate copies of all memory images for all users; must provide direct access to these memory images
- **Roll out, roll in** – swapping variant used for priority-based scheduling algorithms; lower-priority process is swapped out so higher-priority process can be loaded and executed
- Major part of swap time is transfer time; total transfer time is directly proportional to the amount of memory swapped
- System maintains a **ready queue** of ready-to-run processes which have memory images on disk

# Swapping

- Does the swapped out process need to swap back in to same physical addresses?
- Depends on address binding method
  - Plus consider pending I/O to / from process memory space
- Modified versions of swapping are found on many systems (i.e., UNIX, Linux, and Windows)
  - Swapping normally disabled
  - Started if more than threshold amount of memory allocated
  - Disabled again once memory demand reduced below threshold

# Schematic View of Swapping

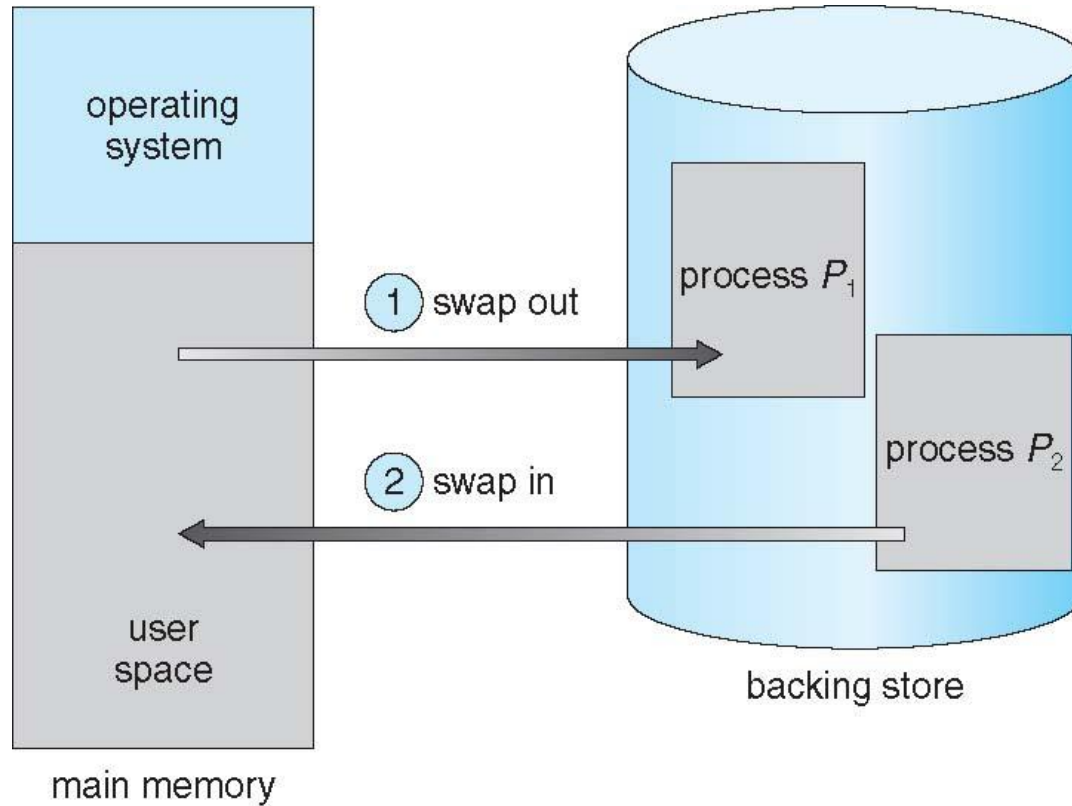



# Context Switch Time including Swapping

- If next processes to be put on CPU is not in memory, need to swap out a process and swap in target process
- Context switch time can then be very high
- 100MB process swapping to hard disk with transfer rate of 50MB/sec
  - Swap out time of 2000 ms
  - Plus swap in of same sized process
  - Total context switch swapping component time of 4000ms (4 seconds)
- Can reduce if reduce size of memory swapped – by knowing how much memory really being used
  - System calls to inform OS of memory use via `request_memory()` and `release_memory()`

## Context Switch Time and Swapping (Cont.)

- Other constraints as well on swapping
  - Pending I/O – can't swap out as I/O would occur to wrong process
  - Or always transfer I/O to kernel space, then to I/O device
    - Known as **double buffering**, adds overhead
- Standard swapping not used in modern operating systems
  - But modified version common
    - Swap only when free memory extremely low

# Swapping on Mobile Systems

- Not typically supported
  - Flash memory based
    - Small amount of space
    - Limited number of write cycles
    - Poor throughput between flash memory and CPU on mobile platform
- Instead use other methods to free memory if low
  - iOS *asks* apps to voluntarily relinquish allocated memory
    - Read-only data thrown out and reloaded from flash if needed
    - Failure to free can result in termination
  - Android terminates apps if low free memory, but first writes **application state** to flash for fast restart
  - Both OSes support paging as discussed below

# Contiguous Allocation

- Main memory must support both OS and user processes
- Limited resource, must allocate efficiently
- Contiguous allocation is one early method
- Main memory usually into two **partitions**:
  - Resident operating system, usually held in low memory with interrupt vector
  - User processes then held in high memory
  - Each process contained in single contiguous section of memory

# Contiguous Allocation

- Relocation registers used to protect user processes from each other, and from changing operating-system code and data
  - Base register contains value of smallest physical address
  - Limit register contains range of logical addresses – each logical address must be less than the limit register
  - MMU maps logical address *dynamically*
  - Can then allow actions such as kernel code being **transient** and kernel changing size

# Hardware Support for Relocation and Limit Registers

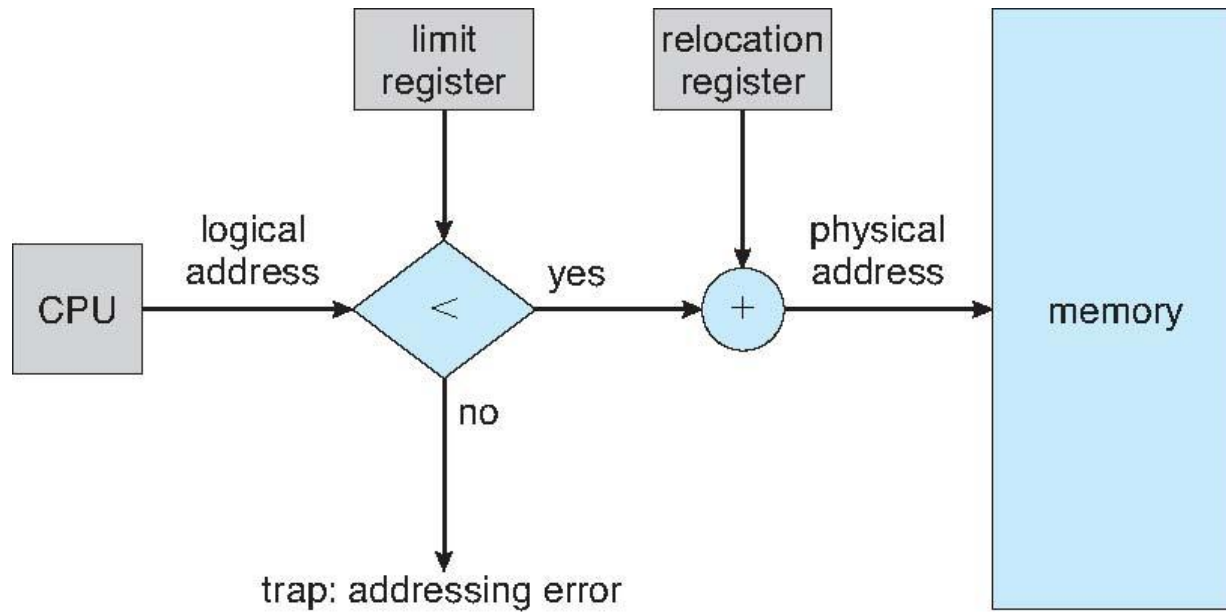

# Multiple-partition allocation

- Multiple-partition allocation

- Degree of multiprogramming limited by number of partitions
- **Variable-partition** sizes for efficiency (sized to a given process' needs)
- **Hole** – block of available memory; holes of various size are scattered throughout memory
- When a process arrives, it is allocated memory from a hole large enough to accommodate it
- Process exiting frees its partition, adjacent free partitions combined
- Operating system maintains information about:

a) allocated partitions    b) free partitions (hole)

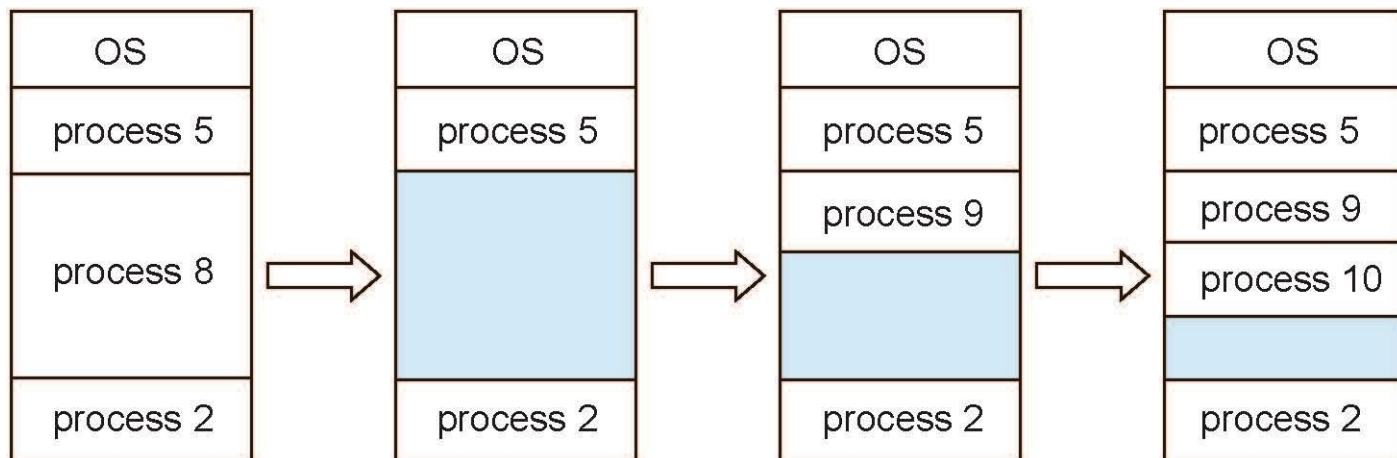

# Dynamic Storage-Allocation Problem

How to satisfy a request of size  $n$  from a list of free holes?

- **First-fit**: Allocate the *first* hole that is big enough
- **Best-fit**: Allocate the *smallest* hole that is big enough; must search entire list, unless ordered by size
  - Produces the smallest leftover hole
- **Worst-fit**: Allocate the *largest* hole; must also search entire list
  - Produces the largest leftover hole

First-fit and best-fit better than worst-fit in terms of speed and storage utilization



# Fragmentation

- **External Fragmentation** – total memory space exists to satisfy a request, but it is not contiguous
- **Internal Fragmentation** – allocated memory may be slightly larger than requested memory; this size difference is memory internal to a partition, but not being used
- First fit analysis reveals that given  $N$  blocks allocated,  $0.5 N$  blocks lost to fragmentation
  - $1/3$  may be unusable -> **50-percent rule**

# Fragmentation

- Reduce external fragmentation by **compaction**
  - Shuffle memory contents to place all free memory together in one large block
  - Compaction is possible *only* if relocation is dynamic, and is done at execution time
  - I/O problem
    - Latch job in memory while it is involved in I/O
    - Do I/O only into OS buffers
- Now consider that backing store has same fragmentation problems

# Segmentation

- Memory-management scheme that supports user view of memory
- A program is a collection of segments
  - A segment is a logical unit such as:
    - main program
    - procedure
    - function
    - method
    - object
    - local variables, global variables
    - common block
    - stack
    - symbol table
    - arrays

# User's View of a Program

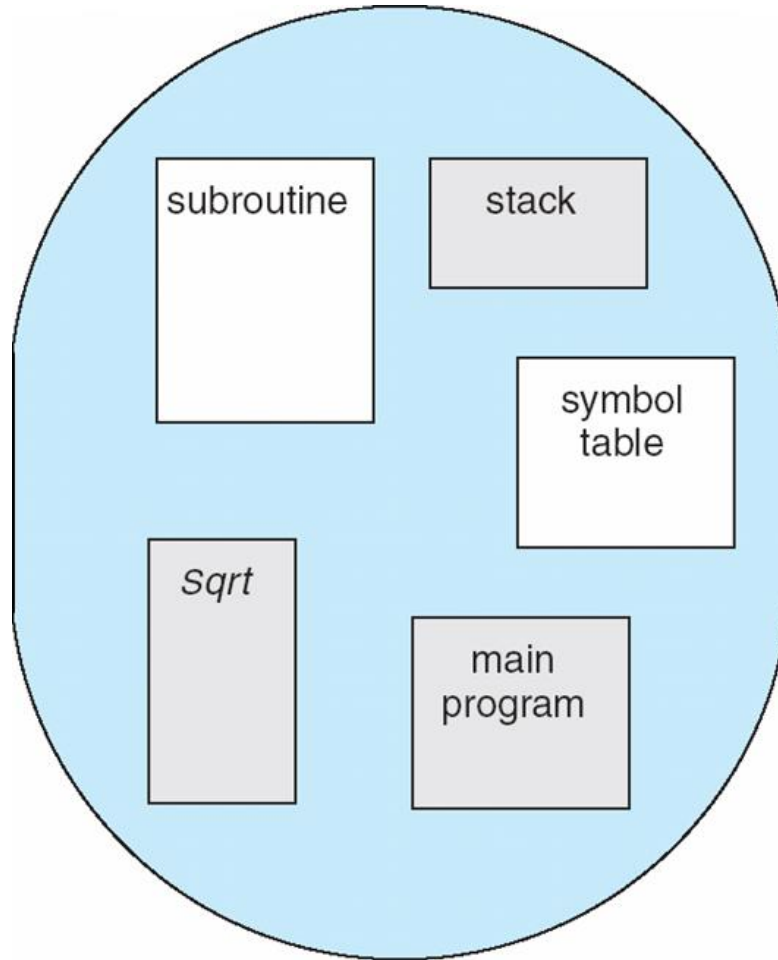

logical address

# Logical View of Segmentation

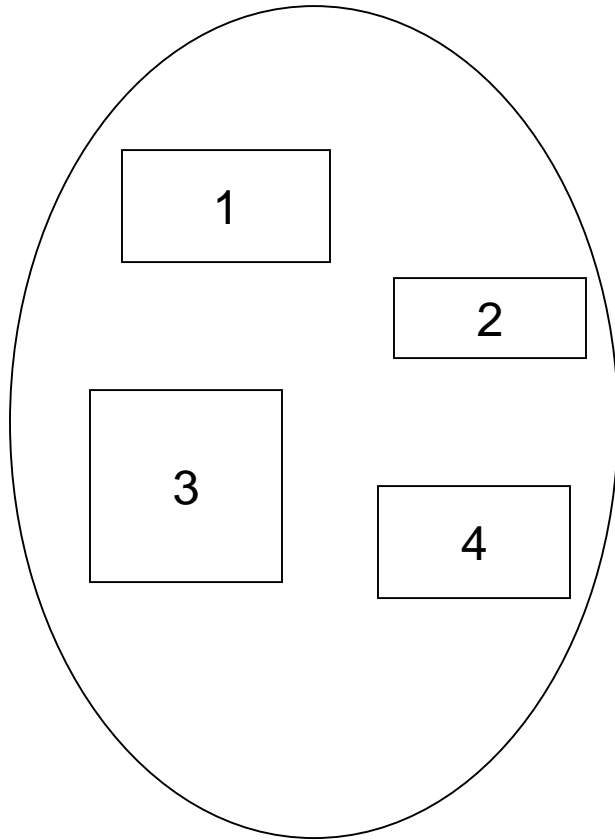

user space

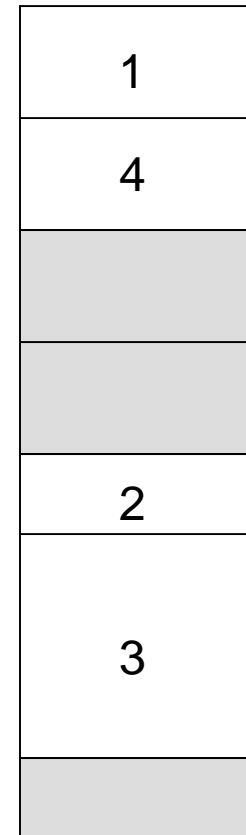

physical memory space

# Segmentation Architecture

- Logical address consists of a two tuple:  
    <segment-number, offset>,
- **Segment table** – maps two-dimensional physical addresses; each table entry has:
  - **base** – contains the starting physical address where the segments reside in memory
  - **limit** – specifies the length of the segment
- **Segment-table base register (STBR)** points to the segment table's location in memory
- **Segment-table length register (STLR)** indicates number of segments used by a program;  
    segment number **s** is legal if **s** < **STLR**

# Segmentation Architecture

- Protection
  - With each entry in segment table associate:
    - validation bit = 0  $\Rightarrow$  illegal segment
    - read/write/execute privileges
- Protection bits associated with segments; code sharing occurs at segment level
- Since segments vary in length, memory allocation is a dynamic storage-allocation problem
- A segmentation example is shown in the following diagram

# Segmentation Hardware

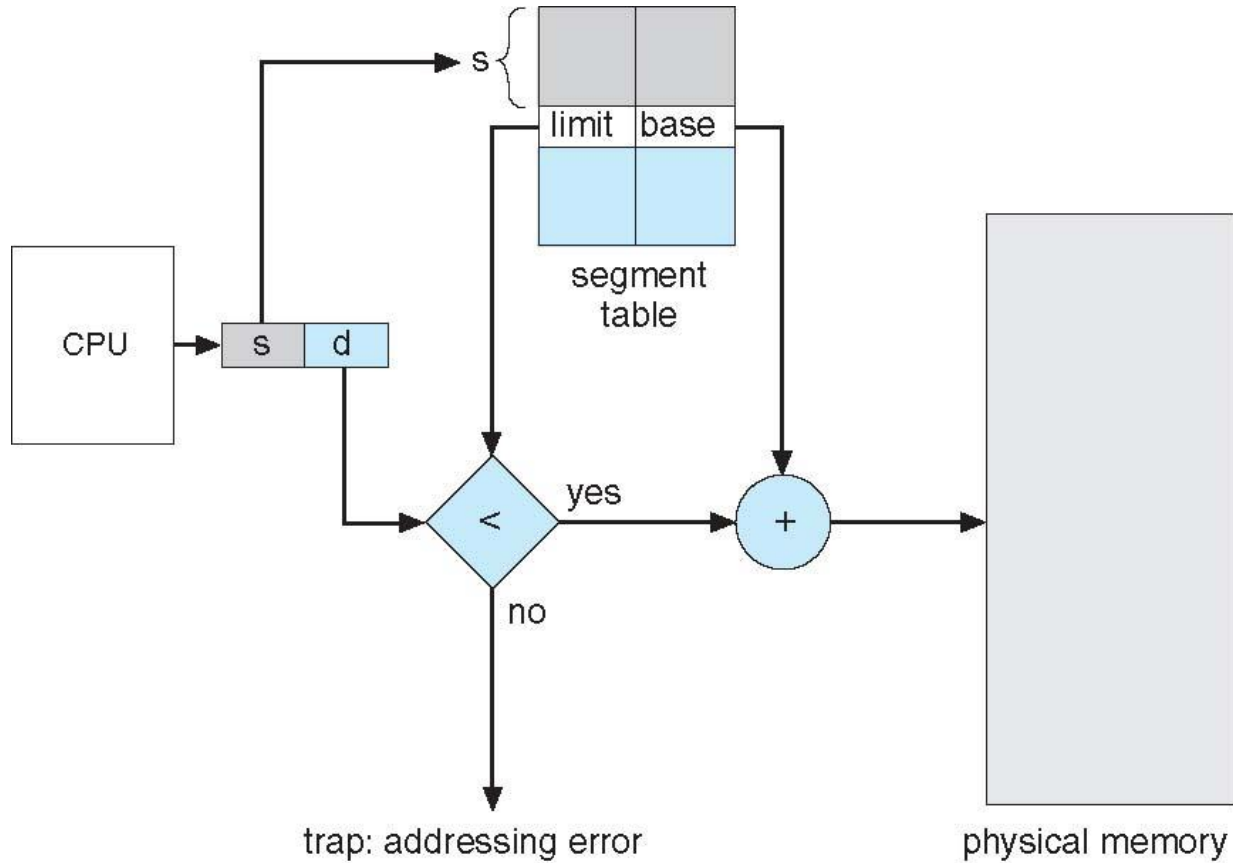



# Paging

- Physical address space of a process can be noncontiguous; process is allocated physical memory whenever the latter is available
  - Avoids external fragmentation
  - Avoids problem of varying sized memory chunks
- Divide physical memory into fixed-sized blocks called **frames**
  - Size is power of 2, between 512 bytes and 16 Mbytes
- Divide logical memory into blocks of same size called **pages**
- Keep track of all free frames
- To run a program of size  **$N$**  pages, need to find  **$N$**  free frames and load program
- Set up a **page table** to translate logical to physical addresses
- Backing store likewise split into pages
- Still have Internal fragmentation

# Address Translation Scheme

- Address generated by CPU is divided into:
  - **Page number** ( $p$ ) – used as an index into a **page table** which contains base address of each page in physical memory
  - **Page offset** ( $d$ ) – combined with base address to define the physical memory address that is sent to the memory unit

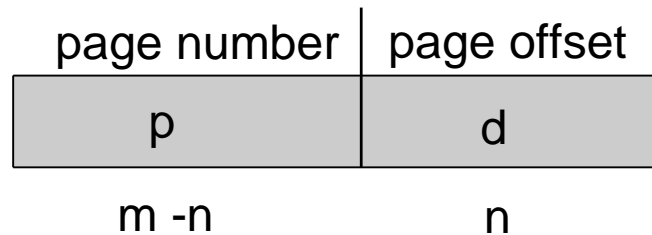

- For given logical address space  $2^m$  and page size  $2^n$

# Paging Hardware

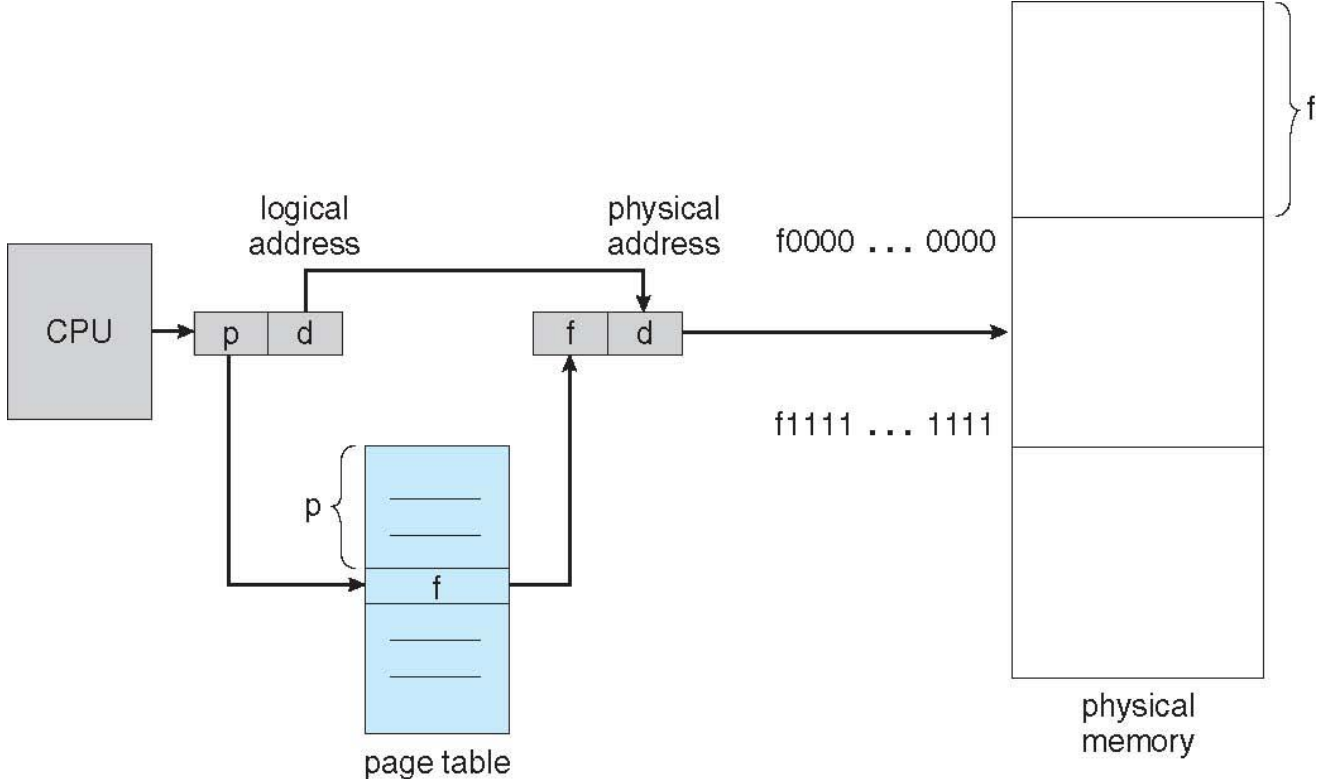

# Paging Model of Logical and Physical Memory

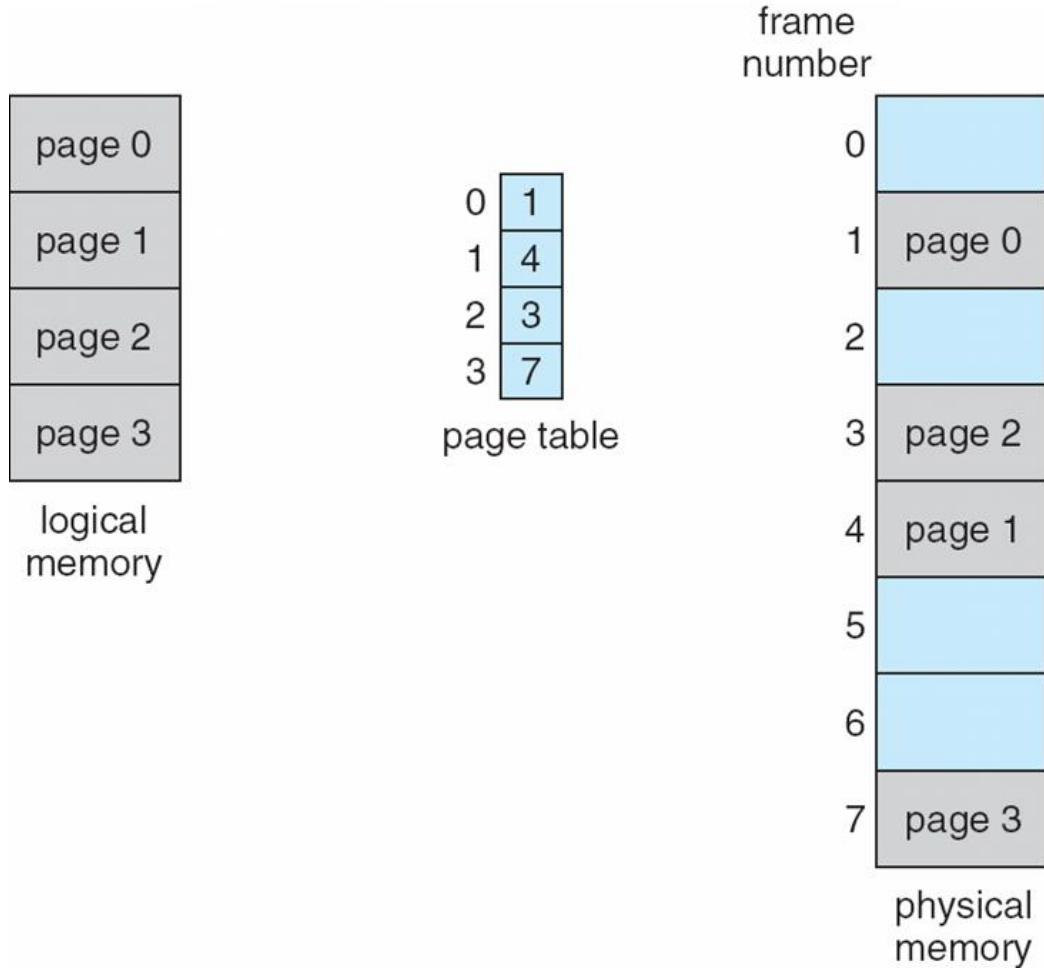

# Paging Example

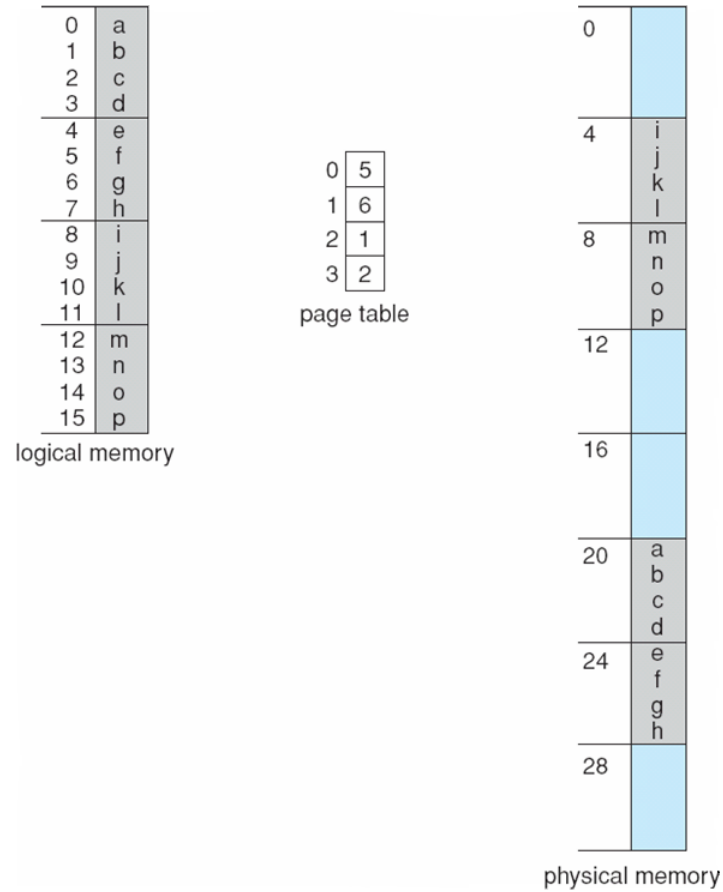

$n=2$  and  $m=4$  32-byte memory and 4-byte pages

# Paging (Cont.)

- Calculating internal fragmentation
  - Page size = 2,048 bytes
  - Process size = 72,766 bytes
  - 35 pages + 1,086 bytes
  - Internal fragmentation of  $2,048 - 1,086 = 962$  bytes
  - Worst case fragmentation = 1 frame – 1 byte
  - On average fragmentation =  $1 / 2$  frame size
  - So small frame sizes desirable?
  - But each page table entry takes memory to track
  - Page sizes growing over time
    - Solaris supports two page sizes – 8 KB and 4 MB
- Process view and physical memory now very different
- By implementation process can only access its own memory

# Free Frames

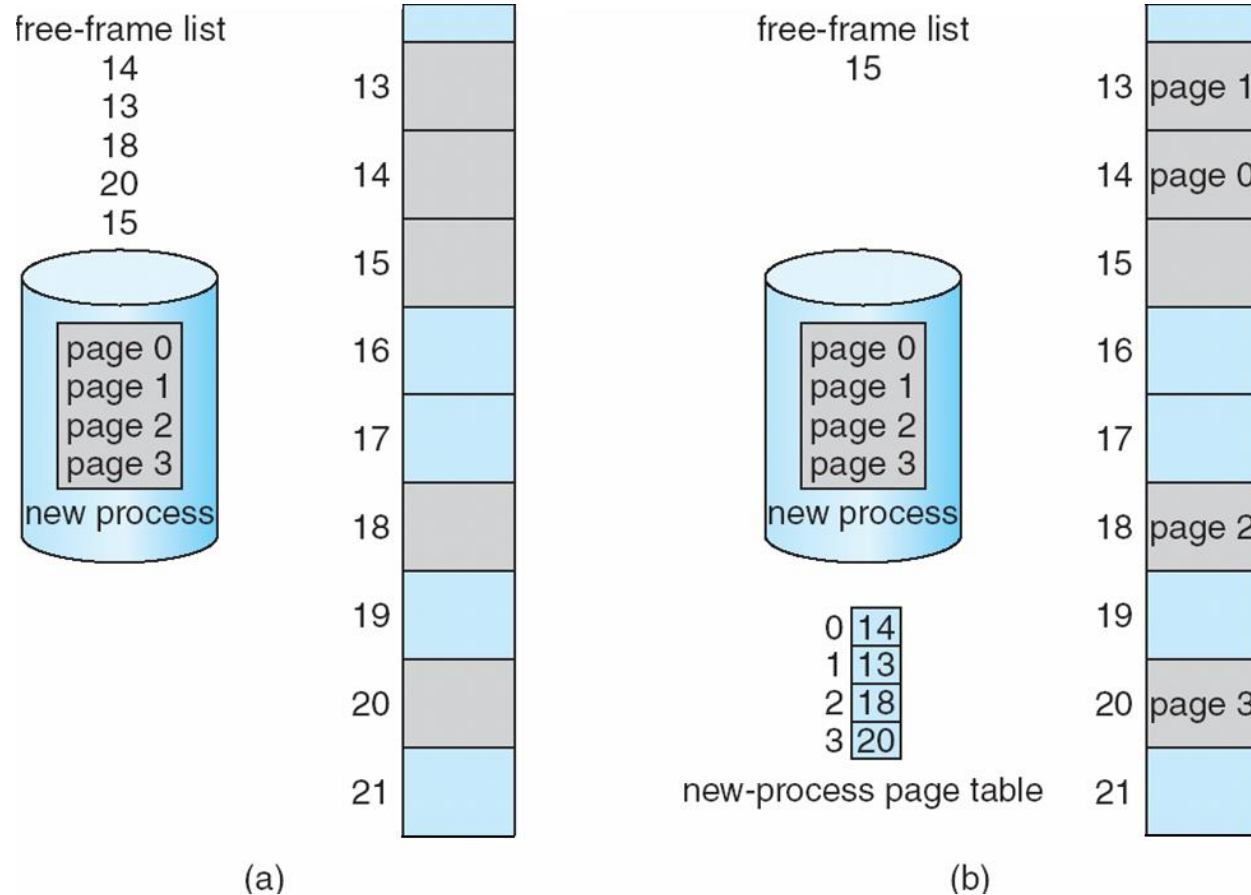

Before allocation

After allocation

# Implementation of Page Table

- Page table is kept in main memory
- **Page-table base register (PTBR)** points to the page table
- **Page-table length register (PTLR)** indicates size of the page table
- In this scheme every data/instruction access requires two memory accesses
  - One for the page table and one for the data / instruction
- The two memory access problem can be solved by the use of a special fast-lookup hardware cache called **associative memory** or **translation look-aside buffers (TLBs)**



# Implementation of Page Table

- Some TLBs store **address-space identifiers (ASIDs)** in each TLB entry – uniquely identifies each process to provide address-space protection for that process
  - Otherwise need to flush at every context switch
- TLBs typically small (64 to 1,024 entries)
- On a TLB miss, value is loaded into the TLB for faster access next time
  - Replacement policies must be considered
  - Some entries can be **wired down** for permanent fast access

# Associative Memory

- Associative memory – parallel search

Page #	Frame #

- Address translation (p, d)
  - If p is in associative register, get frame # out
  - Otherwise get frame # from page table in memory

# Paging Hardware With TLB

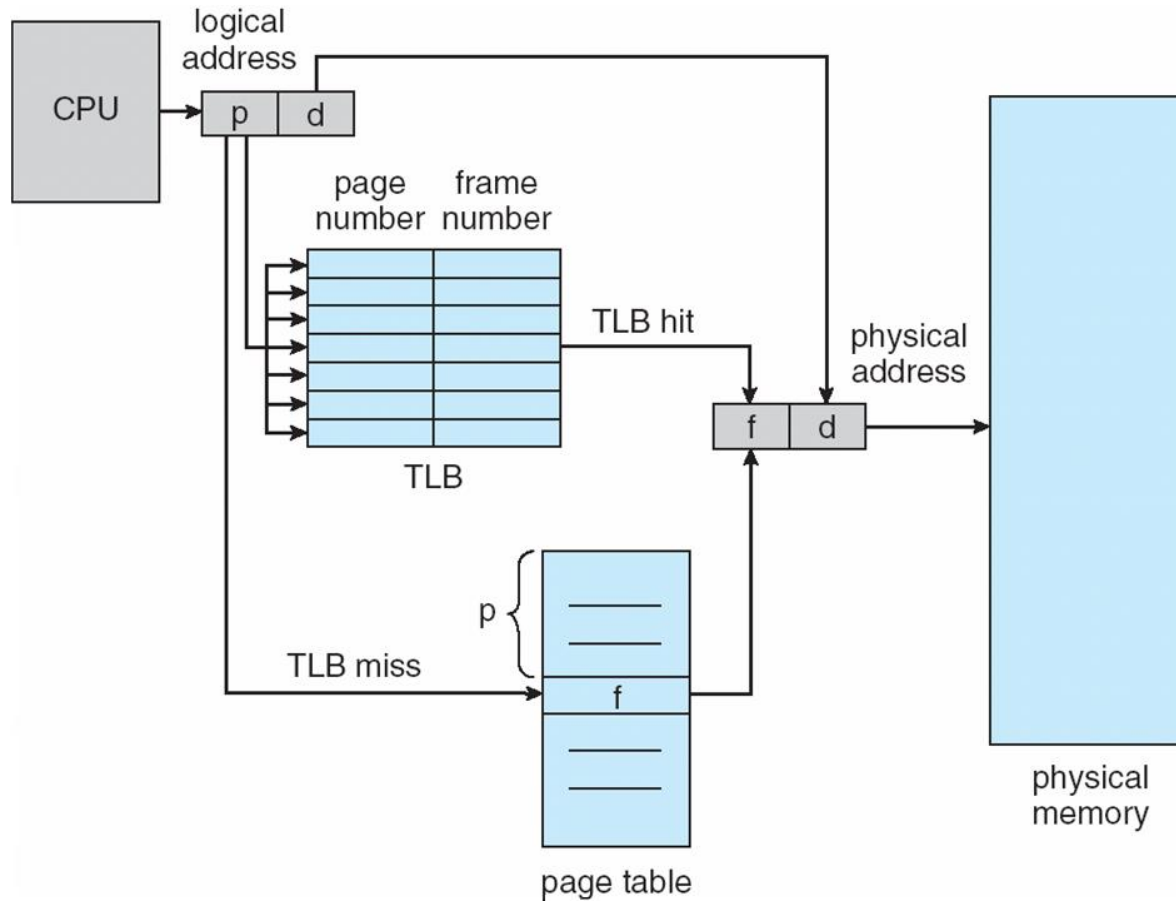

# Effective Access Time

- Associative Lookup =  $\varepsilon$  time unit
  - Can be < 10% of memory access time
- Hit ratio =  $\alpha$ 
  - Hit ratio – percentage of times that a page number is found in the associative registers; ratio related to number of associative registers
- Consider  $\alpha = 80\%$ ,  $\varepsilon = 20\text{ns}$  for TLB search,  $100\text{ns}$  for memory access

- **Effective Access Time (EAT)**

$$\begin{aligned} \text{EAT} &= (1 + \varepsilon) \alpha + (2 + \varepsilon)(1 - \alpha) \\ &= 2 + \varepsilon - \alpha \end{aligned}$$

- Consider  $\alpha = 80\%$ ,  $\varepsilon = 20\text{ns}$  for TLB search,  $100\text{ns}$  for memory access
  - $\text{EAT} = 0.80 \times 100 + 0.20 \times 200 = 120\text{ns}$
- Consider more realistic hit ratio ->  $\alpha = 99\%$ ,  $\varepsilon = 20\text{ns}$  for TLB search,  $100\text{ns}$  for memory access
  - $\text{EAT} = 0.99 \times 100 + 0.01 \times 200 = 101\text{ns}$

# Memory Protection

- Memory protection implemented by associating protection bit with each frame to indicate if read-only or read-write access is allowed
  - Can also add more bits to indicate page execute-only, and so on
- **Valid-invalid** bit attached to each entry in the page table:
  - “valid” indicates that the associated page is in the process’ logical address space, and is thus a legal page
  - “invalid” indicates that the page is not in the process’ logical address space
  - Or use **page-table length register (PTLR)**
- Any violations result in a trap to the kernel

# Valid (v) or Invalid (i) Bit In A Page Table

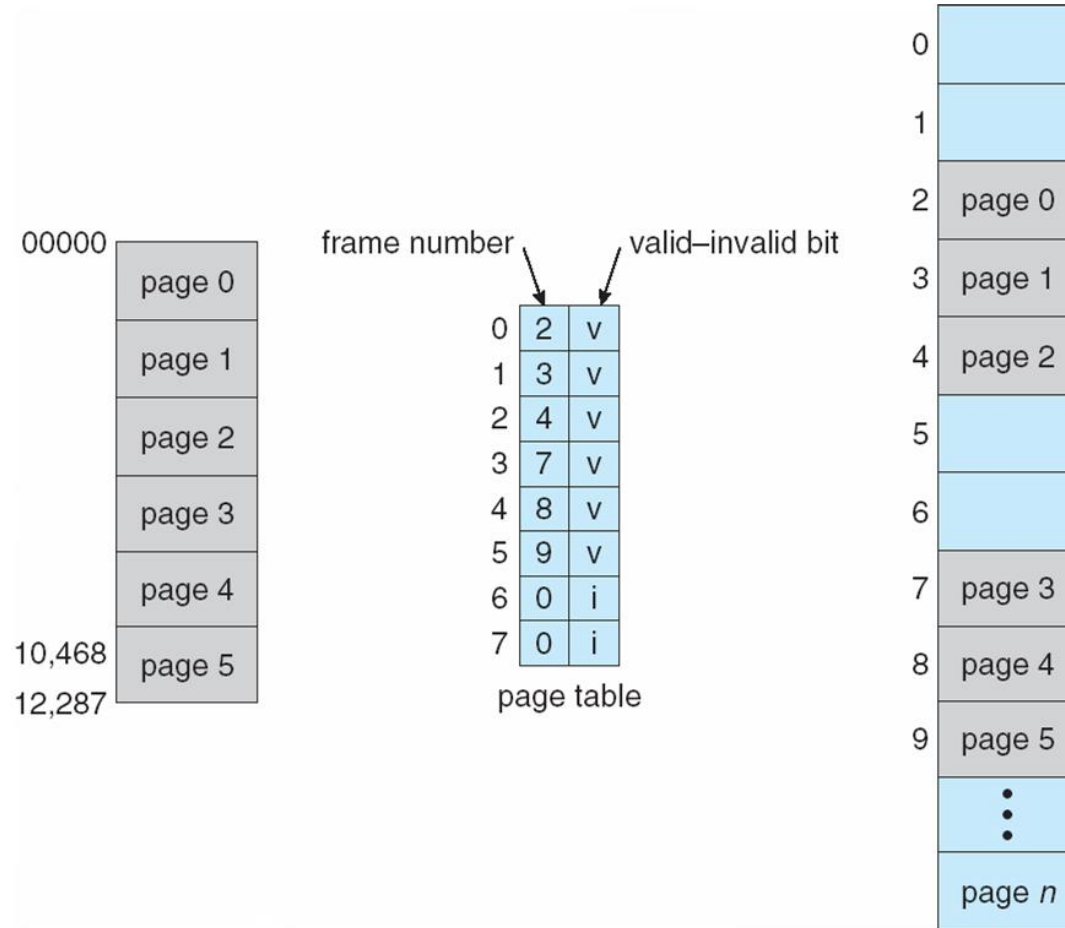

# Shared Pages

- **Shared code**
  - One copy of read-only (**reentrant**) code shared among processes (i.e., text editors, compilers, window systems)
  - Similar to multiple threads sharing the same process space
  - Also useful for interprocess communication if sharing of read-write pages is allowed
- **Private code and data**
  - Each process keeps a separate copy of the code and data
  - The pages for the private code and data can appear anywhere in the logical address space

# Shared Pages Example

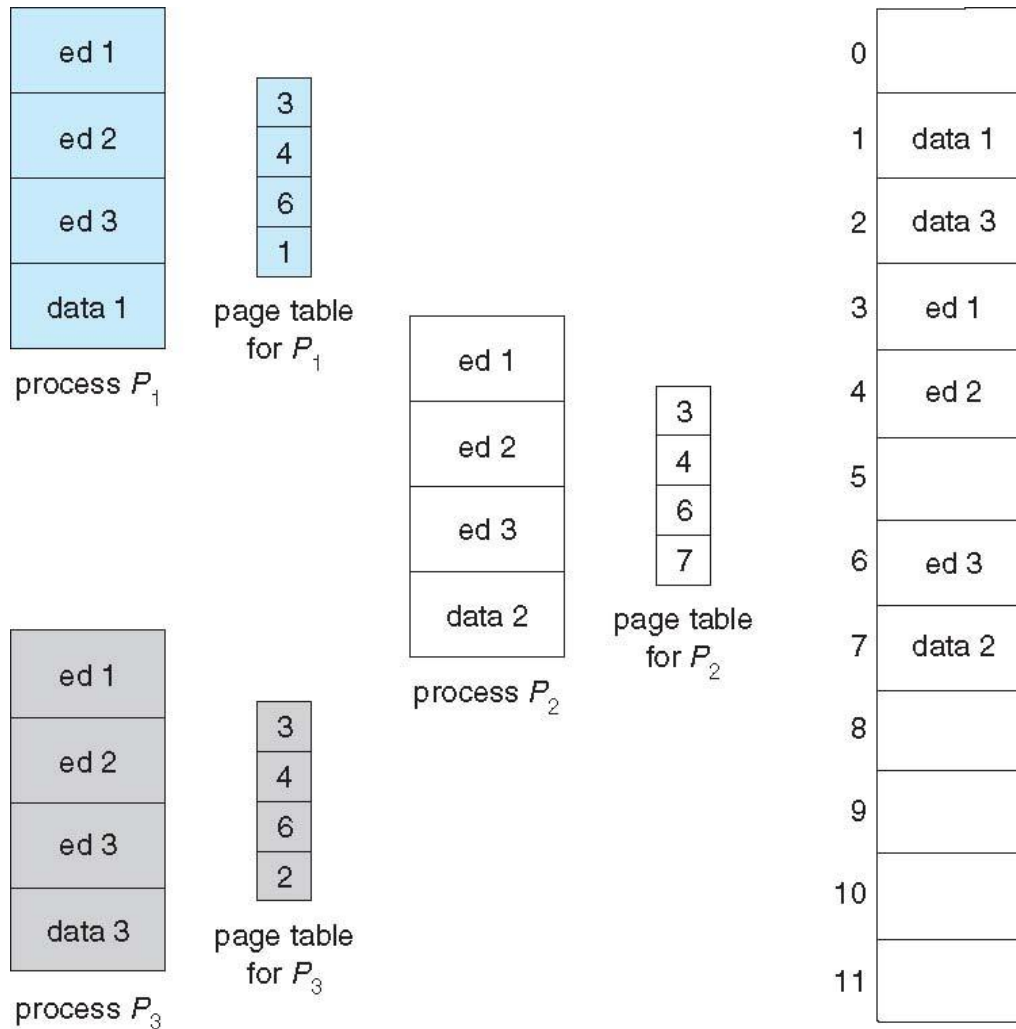



# Structure of the Page Table

- Memory structures for paging can get huge using straight-forward methods
  - Consider a 32-bit logical address space as on modern computers
  - Page size of 4 KB ( $2^{12}$ )
  - Page table would have 1 million entries ( $2^{32} / 2^{12}$ )
  - If each entry is 4 bytes -> 4 MB of physical address space / memory for page table alone
    - That amount of memory used to cost a lot
    - Don't want to allocate that contiguously in main memory
- Hierarchical Paging
- Hashed Page Tables
- Inverted Page Tables

# Hierarchical Page Tables

- Break up the logical address space into multiple page tables
- A simple technique is a two-level page table
- We then page the page table

# Two-Level Page-Table Scheme

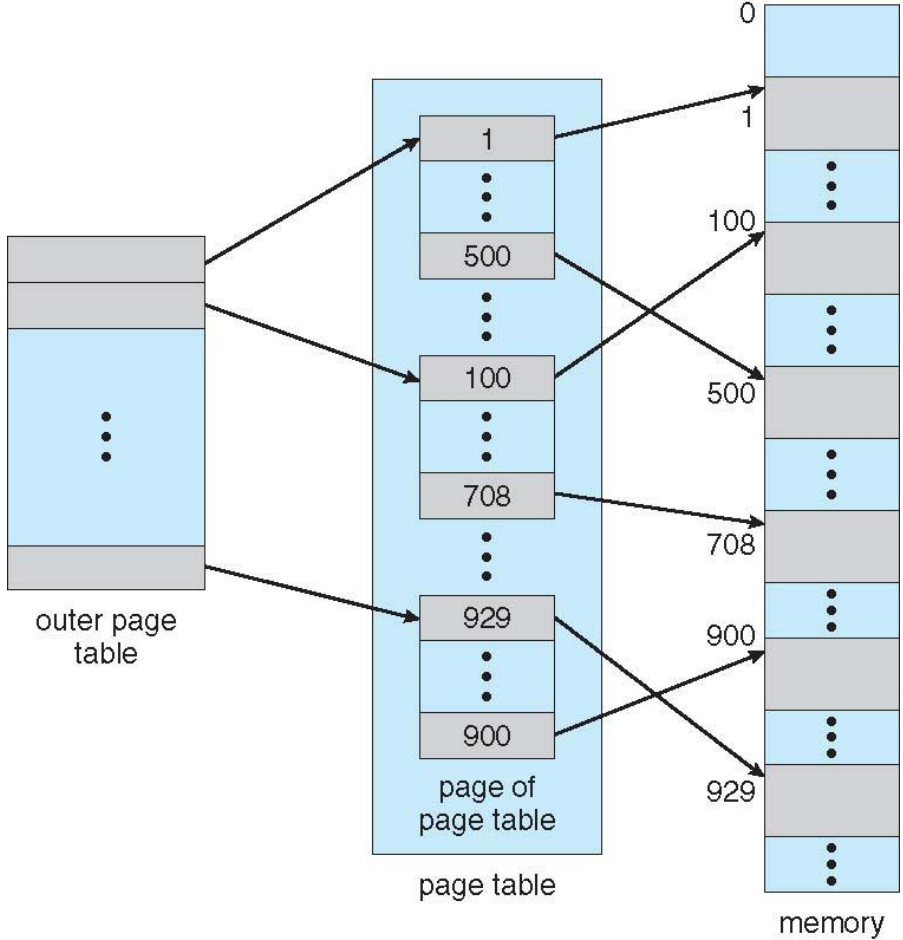

# Two-Level Paging Example

- A logical address (on 32-bit machine with 1K page size) is divided into:
  - a page number consisting of 22 bits
  - a page offset consisting of 10 bits
- Since the page table is paged, the page number is further divided into:
  - a 12-bit page number
  - a 10-bit page offset

- Thus, a logical address is as follows:

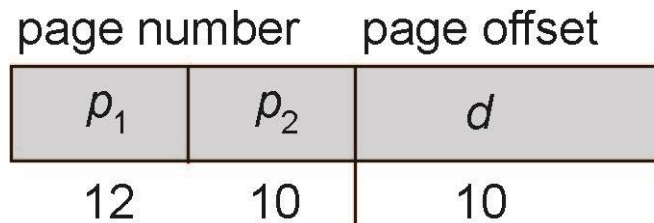

- where  $p_1$  is an index into the outer page table, and  $p_2$  is the displacement within the page of the inner page table
- Known as **forward-mapped page table**

# Address-Translation Scheme

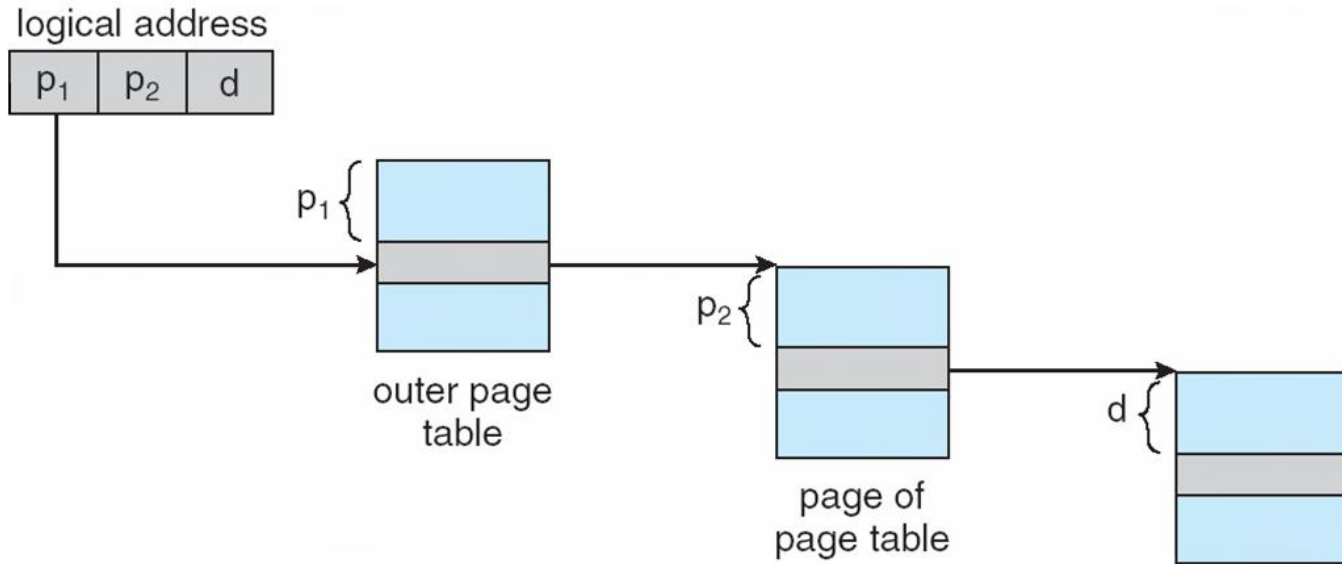

# 64-bit Logical Address Space

- Even two-level paging scheme not sufficient
- If page size is 4 KB ( $2^{12}$ )
  - Then page table has  $2^{52}$  entries
  - If two level scheme, inner page tables could be  $2^{10}$  4-byte entries

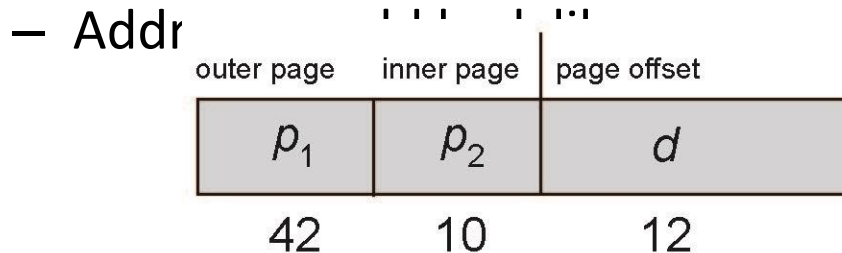

- Outer page table has  $2^{42}$  entries or  $2^{44}$  bytes
- One solution is to add a  $2^{\text{nd}}$  outer page table
- But in the following example the  $2^{\text{nd}}$  outer page table is still  $2^{34}$  bytes in size
  - And possibly 4 memory access to get to one physical memory location

# Three-level Paging Scheme

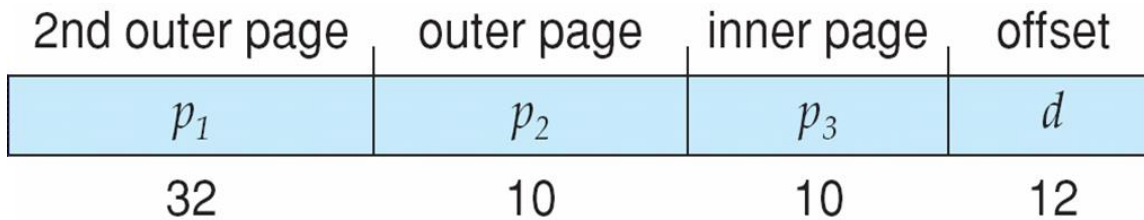
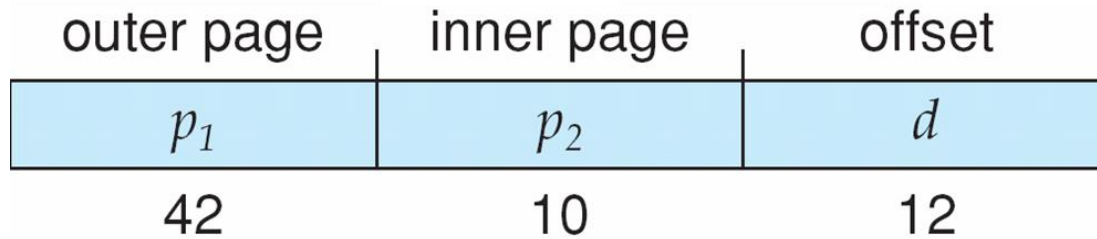

# Hashed Page Tables

- Common in address spaces  $> 32$  bits
- The virtual page number is hashed into a page table
  - This page table contains a chain of elements hashing to the same location
- Each element contains (1) the virtual page number (2) the value of the mapped page frame (3) a pointer to the next element
- Virtual page numbers are compared in this chain searching for a match
  - If a match is found, the corresponding physical frame is extracted
- Variation for 64-bit addresses is **clustered page tables**
  - Similar to hashed but each entry refers to several pages (such as 16) rather than 1
  - Especially useful for **sparse** address spaces (where memory references are non-contiguous and scattered)



# Hashed Page Table

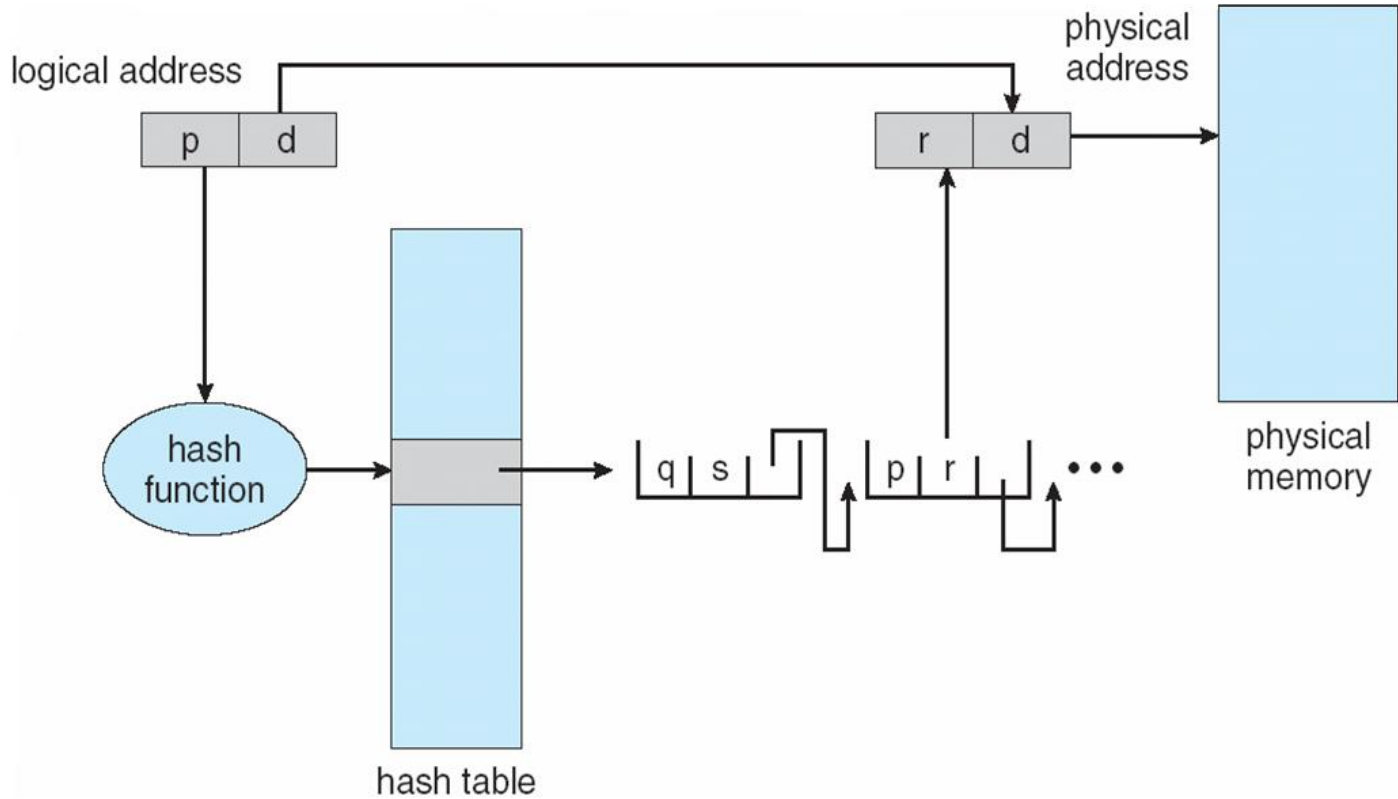

# Inverted Page Table

- Rather than each process having a page table and keeping track of all possible logical pages, track all physical pages
- One entry for each real page of memory
- Entry consists of the virtual address of the page stored in that real memory location, with information about the process that owns that page
- Decreases memory needed to store each page table, but increases time needed to search the table when a page reference occurs
- Use hash table to limit the search to one — or at most a few — page-table entries
  - TLB can accelerate access
- But how to implement shared memory?
  - One mapping of a virtual address to the shared physical address

# Inverted Page Table Architecture

